



# INSTALLATION INSTRUCTIONS

## FUEL PUMP HANGER

08+ SUBARU IMPREZA/WRX/STI/FORESTER

05-09 SUBARU LEGACY/OUTBACK

Support: [info@radiumauto.com](mailto:info@radiumauto.com)

Document# 19-0095

**WARNING: DO NOT EXPOSE WORK AREA TO ANY SPARKS OR FIRE. DO NOT SMOKE WHILE OPERATING ON THE FUEL SYSTEM. CLEAN UP ALL FUEL SPILLS IMMEDIATELY. WORK IN A WELL VENTILATED AREA.**

1. **Note: It is recommended this install be done with a minimal amount of fuel in the tank. This will reduce fuel spills and make installation easier and safer. Draining the tank is recommended.**

To depressurize the fuel system, remove the fuel pump fuse and start engine. Allow engine to stall to relieve fuel pressure. Remove ignition key and disconnect the battery (as shown).

Caution: Disconnecting the battery (G1) may cancel the fault memories of some control units. Consequently, before disconnecting the car's battery, always interrogate the fault memories.

Unscrew the gas tank filler cap temporarily to relieve any residual air pressure.

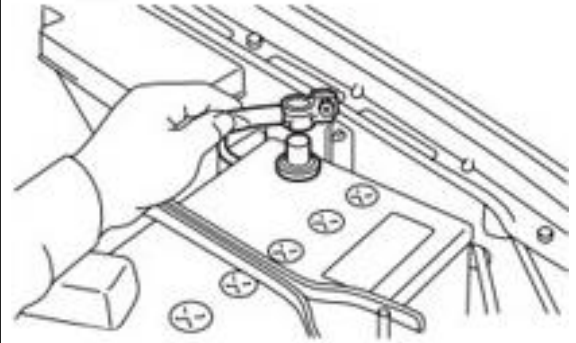

2. Remove the rear bench seat that is held in by three clips. The passenger-side receiver clip is shown. Pull the front of the seat up and back at each corner. Lastly, find the center point of the seat, reach underneath and pull straight up.

Excluding 2015+ models, disconnect the white 12-pin wiring harness connector (shown).

Next, unscrew the four Phillips head screws holding the metal cover plate (shown) in place. Pull the harness and grommet through the hole. Set the metal cover aside and remove the foam.

It is recommended to clean the top of the fuel pump housing and the surrounding area as it will likely be very dirty. This will prevent loose dirt from falling into the fuel tank.

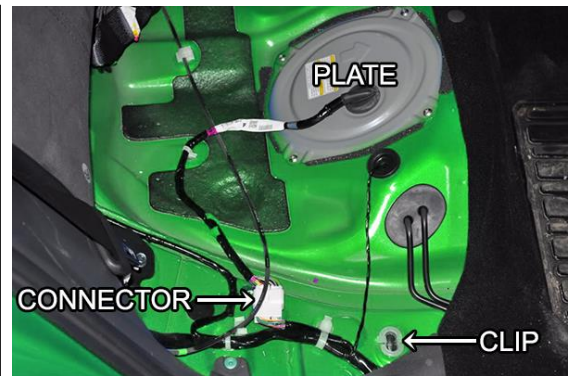

3. Squeeze the tabs and unplug the wiring connector on top of the pump housing.

Next, remove the fuel hoses, remembering where each routes. First, push the fuel fitting connectors further onto the receiver mating tube. For late model Subarus, pull the locking tab upwards. For early Subarus (shown), squeeze the 2 plastic tabs. Simultaneously slide the hoses off. Have a rag handy as fuel will instantly leak out of these connections. It is likely that the white plastic retainers will remain on the mating tubes, as shown. Simply take a micro flat head screwdriver or a pick and gently pry these off and reinsert them into the fuel tubing connectors.

Using an 8mm socket wrench, loosen the eight M5 nuts. Next, hold the fuel pump housing down with one hand and remove each nut one by one by hand as the housing is slightly spring-loaded. Finally, remove the black steel bracket and set aside as it will be reused.

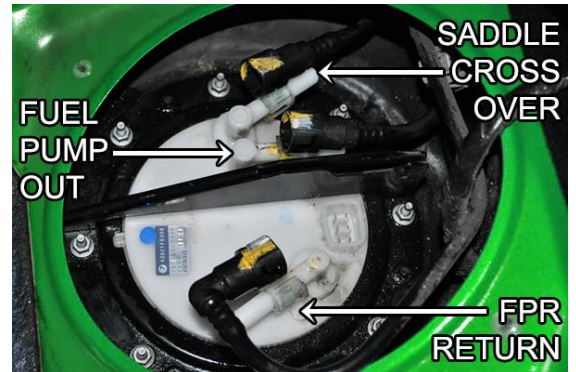

4. Before removing the OEM fuel pump housing, place an empty bucket nearby as there will be residual fuel inside the gas tank. Also, be careful not to damage the fuel level sender float arm when removing. A trick is to tilt the fuel pump housing towards the left side of the vehicle then pull up and out. Place the pump housing into the bucket to drain.

Remove the large rubber gasket (shown top right). Note that this gasket is not symmetrical and has a specific orientation. There are 3 protruding rubber tabs that must be aligned correctly with the steel bracket.

Clean the fuel pump housing and set it onto a workbench. The only two parts that will be reused are the fuel level sender and the fuel temperature sensor (if equipped).



5. NOTE: skip over all steps regarding the fuel temperature sensor for newer Subaru models that did not come standard with this sensor.

To remove the fuel level sensor and fuel temperature sender from the OEM fuel pump hanger, first depress the thumb tab and unplug the 4-pin connector from underneath the top plate. Next, pry and pop the fuel temperature sensor probe out of the securing tabs.

To remove the fuel level sender, press the thumb tab inwards and simultaneously push the module up and out gently until it unlocks, as shown. Be careful not to damage the circuit board or bend the float arm. NOTE: For Subaru FA20F vehicle models, the level sender is different than what is shown. However, all steps above still apply.

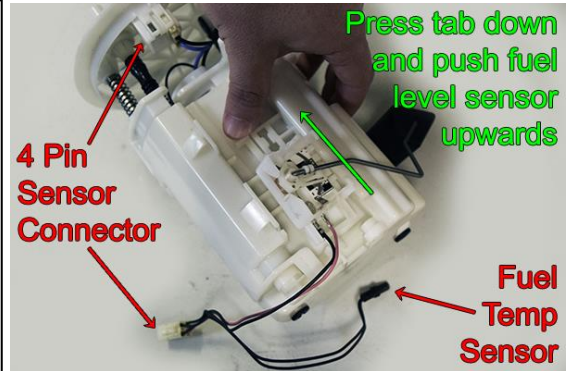

6. **If this kit was shipped from Radium after 9/1/18, this step does not apply and should be skipped. A service-free venturi jet pump was implemented that features a pressure relief valve.**

If this kit was shipped from Radium prior to 9/1/18, there will be 2 different venturi jet pump orifices included. The preinstalled "green" orifice is typically best for single pump applications. The "gold" orifice is typically best for dual pump applications. The proper orifice will be determined by return line backpressure. This is dictated by many factors including: flow rate of pump(s), staged pumps, engine fuel consumption, diameter and length of return hose, etc.

The venturi jet pump O-rings MUST be lubricated prior to assembly. If installing fuel pumps, the jet pump hose assembly can stay intact unless the orifice needs to be swapped.

**VENTURI INLET: FUEL FROM FPR RETURN**

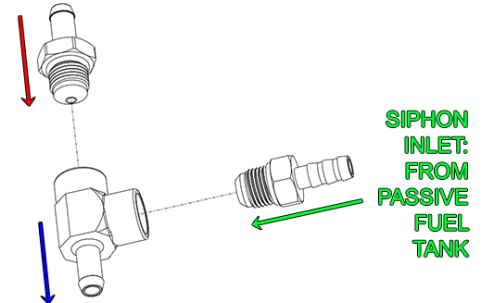

7. **Skip Steps 7-13 if the Radium unit came preassembled with fuel pumps already installed and the vehicle does not have a temperature sensor.**

To install fuel pumps and/or the OEM fuel temperature sensor, the unit must be partially disassembled.

Using a 3mm Allen wrench, remove the 4 upper external collector box bolts (2 on each side). Pull up and separate the hanger from the collector box, as shown.

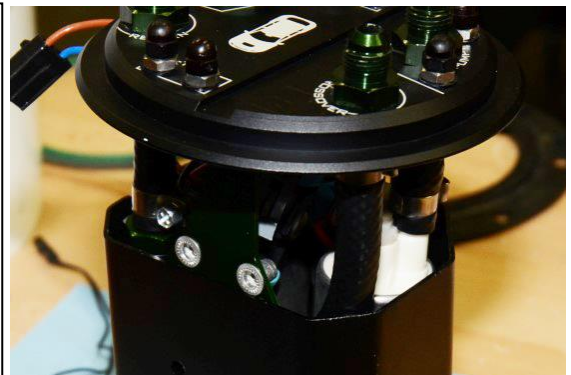

8. To install fuel pumps, remove the 3 internal pump hanger bolts using a 4mm Allen wrench. For dual fuel pump applications, remove the "PUMP 2" port plug and replace with the included green bulkhead fitting (lubricate O-ring first).

In some instances, it may be necessary to cut the included submersible rubber hose to the specific length. Use the measurements below:

- \* 2.25" (57mm) -> Walbro GSS342
- \* 2.18" (55mm) -> AEM 50-1200 or AEM 50-1000
- \* 2.19" (56mm) -> Walbro F90000262
- \* 1.94" (49mm) -> Walbro F90000267/274 E85

Install the hose(s) to the pump(s) and barb(s). Do not tighten clamps yet.



9. Rotate and align the fuel pump(s) with the cut-outs in the internal pump hanger, as shown. Tighten the EFI hose clamps after the alignment is complete. Reinstall the green internal pump hanger bracket. Next, press the filter sock(s) onto each pump inlet and secure with the star washer included with the sock filter.

NOTE: The Radium Fuel Pump Hanger was designed for a specific type of fuel pump sock filter. Large filter socks which have a rigid internal "skeleton" insert can be difficult since they cannot be formed inside the collector box. See below for filter socks that are recommended:

- RADIUM Engineering, P/N: 14-0143 Filter Sock
- AEM, P/N: 50-1000 (the filter sock that is provided in this fuel pump kit)
- AEM, P/N: 50-1200 (the filter sock that is provided in this fuel pump kit)

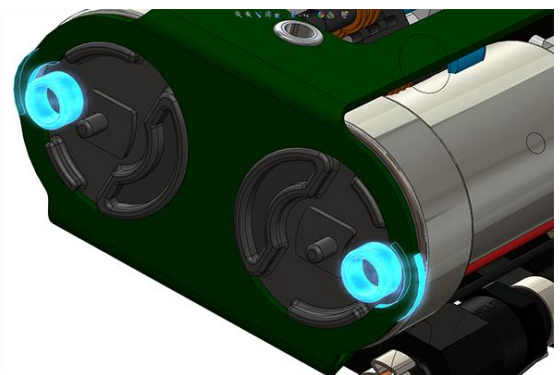

10. Find the hanging internal fuel pump connector and plug it into the fuel pump.

For dual fuel pump applications, secure the included wiring harness (shown) to the "PUMP 2" studs underneath the top hanger plate using a 3/8" nut driver and included lock nuts. Plug into the second pump. Extra lock nuts may be provided. These can be used as spares.

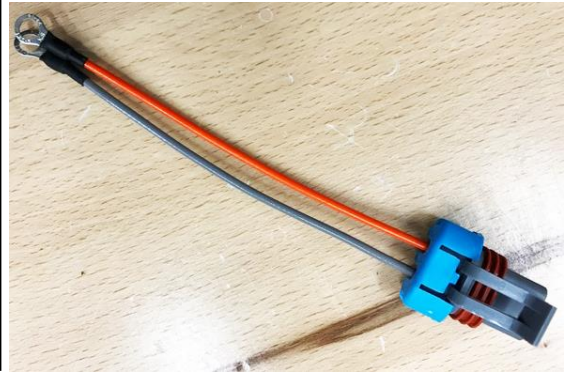

11. To install the fuel temperature sensor (if equipped), cut the 2 black wires at the white OEM connector allowing as much slack as possible. Strip the wires and crimp the 2 included ring terminals using a standard crimp tool.

Secure the ring terminals to the studs underneath the top hanger plate using a 3/8" nut driver. Note: the fuel temperature sensor does not have polarity so wires can be crossed and the readings are unaffected.

Wrap 2 zip ties through the Radium hanger bracket and secure the OEM fuel temperature probe to the inner side of the bracket, as shown.

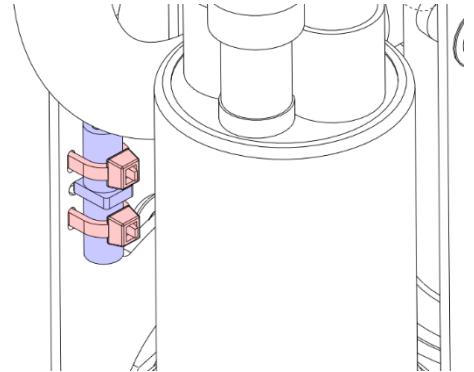

12. Reinstall the hanger into the collector box so the supplied fuel level sender connector is outside the box. Route the 2 wires through the opening in the upper side of the collector box.

Secure the hanger and collector box back together (as shown) using the 4 bolts from Step 7.

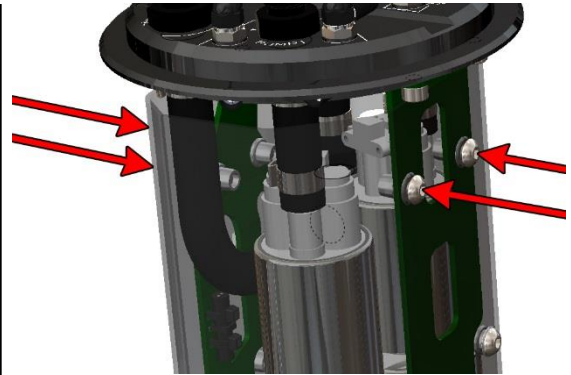

13. To connect the fuel level sender, cut the 2 wires at the OEM white internal connector allowing as much slack as possible. NOTE: One wire will be black and the other will be either yellow or red.

Strip the wires and crimp the 2 included blade terminals using a tool such as Molex 63811-1000. Assemble the included mating connector as shown. Note: the fuel level sender does not have polarity so wires can be crossed and the readings are unaffected.

An extra connector may be included in the kit. This is a spare part.

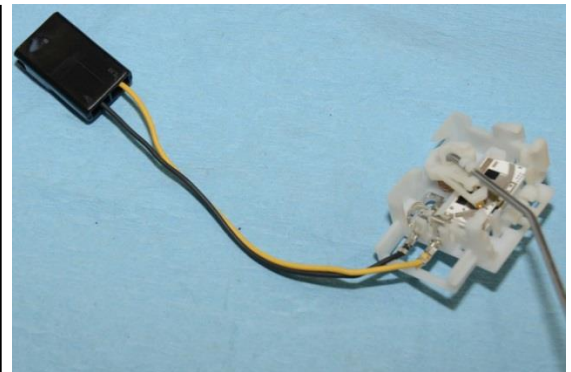

14. **Subaru FA20F vehicles ONLY:**

*NOTE: This application requires 20-0350 Fuel Level Sender Adapter, Denso (sold separately)*

*Remove the two 10mm long button head bolts from the rivet nuts on the lower backside of the collector box using a 3mm Allen hex wrench. These 2 bolts will NOT be reused.*

*Line up the 2 upper holes of the billet fuel level sender adapter to the rivet nuts. Install the new 12mm long socket head bolts and tighten with a 4mm Allen hex wrench. Slide the OEM fuel level sender downwards onto the adapter until the tab locks into place.*

*Plug in the fuel level sender connector.*

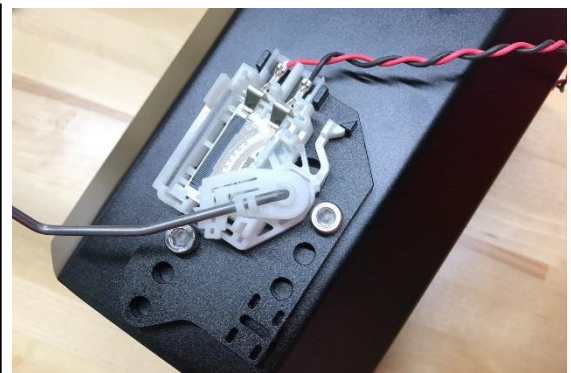

15. **Excluding Subaru FA20F vehicle applications:** Slide the OEM fuel level sender downwards onto the front of the collector box. Use the included bolt to secure the sender in place, as shown. Plug in the fuel level sender connector.

Observe the orientation of the collector box in the picture at right. The check valve should be towards the front of the vehicle.

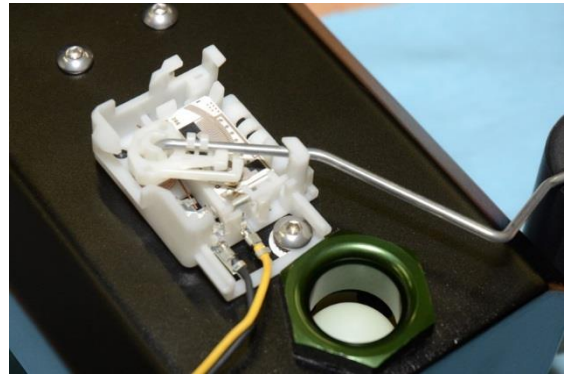

16. Install the OEM rubber gasket to the underside of the mounting flange of the fuel pump hanger top plate. Make sure the rubber nipples are pointing upwards and the gasket is clocked as shown.

NOTE: There is only one way this gasket will go on, so pay close attention and make sure it is clocked correctly.



17. If equipped, fully seat and secure the green/gray plastic gasket from the top side.

NOTE: Only newer Subaru models will have this gasket.



18. Prepare to insert the fuel pump hanger assembly into the fuel tank.

Rotate and insert the float of the hanger assembly into the gas tank first (as shown). Then drop the other side in bringing the assembly vertical. Moving the electrical connectors around may be necessary for proper clearance.

Make note of the orientation graphic on the top plate of the pump hanger assembly and make sure it is aligned correctly with the vehicle.



19. The top plate and gasket should be flush with the mounting ring.

When the fuel pump hanger is fully seated it will look like the example in this picture.



20. Install the OEM metal hold-down bracket and tighten all nuts to factory spec in an alternating cross-pattern.

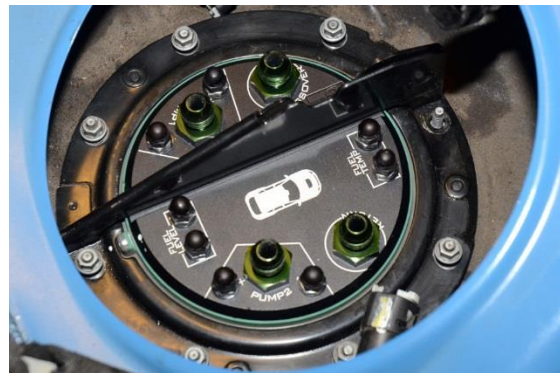

21. Cut off the OEM external 6-position fuel pump connector leaving as much slack as possible.

Strip the ends of the wires, as shown.

NOTE: Newer Subaru models that do not have a fuel temperature sensor will only have 4 wires.



22. Insert a small piece of shrink tube onto each wire, then crimp on the ring terminals included in the kit. Use the 4 smaller ring terminals on the fuel level (and fuel temperature sensor wires if equipped). If powering a single pump using the OEM wiring (check power requirements), crimp the two larger terminals on the pump power and ground wires. NOTE: See the following step for additional details on powering a single pump.

If NOT directly powering a pump with the OEM fuel pump controller, solder wires to the pump power wire (Green/Yellow) and route this to a relay. Green/Red wire will not be used.

Slide the shrink tube in place then apply heat. Extra parts are provided in the kit as spares.

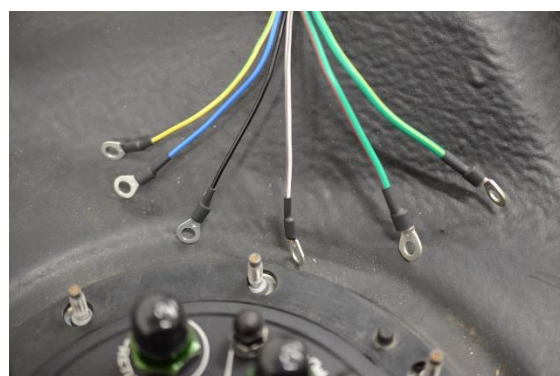

23. Connect the fuel temperature and fuel Level wires to the corresponding terminals on the pump hanger. The sensor wires do not have polarity, so they can be connected to either terminal.

*OEM Fuel Level Sender (Blue Wire)*

*OEM Fuel Level Sender (Black or Black/Yellow or Black/Red)*

*OEM Fuel Temp Sensor (White/Black Wire)*

*OEM Fuel Temp Sensor (Yellow/Green Wire)*

Secure the ring terminals to the studs with the included acorn nuts.

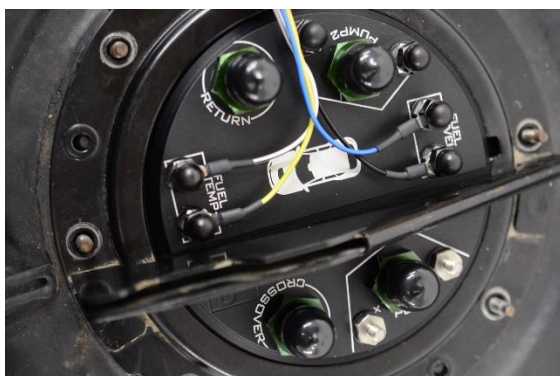

#### 24. **Dual Fuel Pump Applications ONLY:**

Each fuel pump must use an independent fuse and relay to handle the extra current draw. Consider purchasing Radium 17-0031 (shown) for each pump. "Pump 2" in the hanger is powered through the studs labeled "Pump 2 +/-". Refer to the installation instructions for 17-0031 for additional details on wiring.

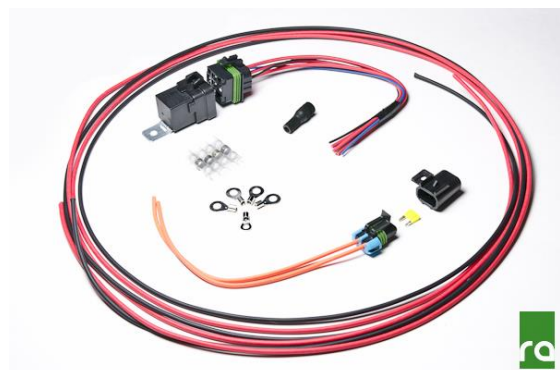

### 25. Single Fuel Pump Applications ONLY:

In some cases, the OEM Subaru fuel pump controller and OEM wiring (designed for <15A) will be sufficient to power the pump in the Radium hanger. To reuse the OEM fuel pump controller and keep the fuel pump duty-cycled, connect "PUMP 1" as follows:

OEM Fuel Pump + (Green/Yellow Wire) ----> Pump1 + terminal

OEM Fuel Pump - (Green/Red Wire) -----> Pump1 - terminal

Use the ring terminals and heat shrink included in the kit and connect the terminated wires to the studs on the top plate, securing with the acorn nuts. If using large gauge wire, use the larger ring terminals and heat shrink.

Alternatively, the OEM fuel pump controller can be bypassed using Radium 17-0031 Wiring Kit, as shown at right. This schematic will run the pump at 100% duty cycle using power directly from battery via the relay.

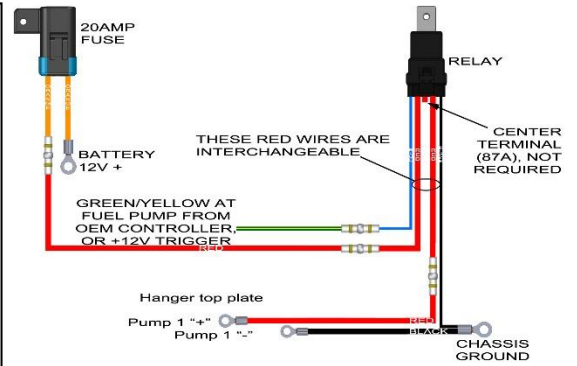

### INSTALLATION: 20-0294-02 Fuel Hanger Plumbing Kit, 08-14 Subaru

Under the rear seat sheet metal, plastic fuel lines run between the active side and passive side of the fuel tank. Remove the passive side fuel tank access cover.

Identify the plastic fuel line that goes from the passive side of the fuel tank to the active side. This is the crossover fuel line. To completely remove this line, disconnect each end and unclip it from the bracket hidden in the cavity under the rear seat sheet metal (shown).

Remove the other two plastic lines. These are the feed and return lines that connect to the metal fuel lines traveling from the front of the vehicle and terminating near the active side of the gas tank.



### INSTALLATION: 20-0294-02 Fuel Hanger Plumbing Kit, 08-14 Subaru

The OEM crossover line will need to be replaced. First, locate the hose with a 90-degree hose end on one end and no hose end on the opposite end. First, install the 90-deg end to the port marked "CROSSOVER" on the fuel hanger. Run the new hose underneath the sheet metal to the passive (left) side of the gas tank.

Next, install the provided plastic SAE quick connect fitting's barb side into the PTFE hose and secure with the included EFI hose clamp (as shown). Lastly, use light oil for O-ring lubrication and install the SAE quick connect fitting on the passive side port where the OEM crossover hose was previously attached. When it is fully seated, a click will be felt. Gently tug the hose connection to verify a positive lock has been made. Adjust the positioning of the fittings as needed for optimal hose routing, then tighten all fittings.



### INSTALLATION: 20-0294-02 Fuel Hanger Plumbing Kit, 08-14 Subaru

For both single and dual pump configurations, route the 24" long hose under the sheet metal. Make sure the 90-degree hose end is on the active side and 45-degree hose end is on the passive side.

For dual pump configurations only, install the 90-degree -6AN female to female adapter on the fuel pump hanger "Pump 1" port. Install the included "Y" adapter, as shown. Use the included short hose with the 90-degree and 180-degree hose ends and route it from the "Pump 2" port (underneath the other hoses) to the "Y" adapter. Connect the 90-degree hose end to the "Y" adapter outlet.

For single pump configurations (not shown), install the 90 degree hose end directly to the "Pump 1" port. Note: The extra PTFE hose, Y-adapter, and 90 degree 6AN fitting can be used later if a second pump is ever installed.



### INSTALLATION: 20-0294-02 Fuel Hanger Plumbing Kit, 08-14 Subaru

On the passive side of the tank, install the included SAE female adapter fitting to the 45 degree hose end and tighten. Attach the SAE female adapter fitting to the OEM hard line with the black plastic cover and secure with the green retaining clip and small screw. Use light oil for O-ring lubrication. Make sure a positive engagement is made. Tighten all fittings and hose ends.

Locate the 30" hose with the 90-degree and 45-degree hose ends. Install the 90-degree end on the fuel pump hanger "RETURN" port. Route the hose under the sheet metal over to the passive side of the tank. Install the included SAE female adapter fitting and connect the hose to the OEM hard line with the white plastic cover. Use light oil for O-ring lubrication. After engaged, install the green retaining clip onto the adapter fitting and secure with the small screw (use a 5/64" Allen wrench).



**INSTALLATION: 20-0294-02 Fuel Hanger Plumbing Kit, 08-14 Subaru**

Reinstall the OEM metal cover plates.

**NOTE:** This kit eliminates the OEM hanger's "post" fuel pump filter. A low micron aftermarket filter should be installed downstream to protect the injectors from debris.

Reconnect the battery and turn the key to the ON position. Confirm the new fuel pumps prime for a few seconds and check for leaks. If no leaks are found, start the vehicle. The engine may run rough for a few seconds until all the air is bled from the fuel system. Recheck for leaks.

**Installation Complete**



**INSTALLATION: 20-0295-11 Fuel Hanger Plumbing Kit, 2015+ Subaru STI, Single Pump**

Install the 90-deg female to female -6AN adapters to the 3 ports.

Orient the 90-deg adapters then install the Radium 3/8" SAE quick connect adapter fittings.

Install the OEM plastic fuel lines to the Radium SAE adapter fittings. Make sure they fully "click" into place and are secure. Adjust the positioning of the fittings as needed for optimal hose routing, then tighten all fittings.

Make sure the factory plastic fuel lines do not become kinked or routed in a way that causes undue stress on the lines.



**INSTALLATION: 20-0295-11 Fuel Hanger Plumbing Kit, 2015+ Subaru STI, Single Pump**

Reinstall the OEM metal cover plate. Reconnect the battery and turn the key to the ON position. Confirm the new fuel pump primes for a few seconds and check for leaks. If no leaks are found, start the vehicle. The engine may run rough for a few seconds until all the air is bled from the fuel system. Recheck for leaks. **Installation Complete**

**NOTES:** 1. This kit eliminates the OEM hanger's "post" fuel pump filter. A low micron aftermarket filter should be installed downstream to protect the injectors from debris. 2. Subaru models which have the FA20F engine do not have a return line. An external fuel pressure regulator (not included) will need to be installed into the fuel system.



**INSTALLATION: 20-0295-12 Fuel Hanger Plumbing Kit, 2015+ Subaru STI, Dual Pump**

Under the rear seat sheet metal, plastic fuel lines run between the active side and passive side of the fuel tank. Remove the passive side fuel tank access cover.

Identify the plastic fuel line that goes from the passive side of the fuel tank to the active side. This is the crossover fuel line and will NOT be removed. However, the other 2 plastic fuel lines will be removed. These are the feed and return lines that connect to the metal fuel lines traveling from the front of the vehicle and terminating near the active side of the gas tank.

To completely remove these lines, disconnect each end and unclip it from the bracket hidden in the cavity under the rear seat sheet metal (shown).



**INSTALLATION: 20-0295-12 Fuel Hanger Plumbing Kit, 2015+ Subaru STI, Dual Pump**

Install the 90-deg female to female -6AN adapter to the port labeled "CROSSOVER". Orient the 90-deg adapter then install the 3/8" SAE quick connect adapter, as shown.

Install the OEM plastic fuel line to the Radium SAE quick connect male adapter fitting. Make sure it fully "clicks" into place and is secure.

Adjust the positioning of the fittings as needed for optimal hose routing, then tighten all fittings. Make sure the OEM plastic fuel line does not kink.



### INSTALLATION: 20-0295-12 Fuel Hanger Plumbing Kit, 2015+ Subaru STi, Dual Pump

Both fuel pump outlets are combined into a single line in the dual pump configuration.

Install the 90-degree -6AN female to female adapter on the fuel pump hanger "Pump 1" port. Install the included "Y" adapter, as shown. Use the included short hose with the 90-degree and 180-degree hose ends and route it from the "Pump 2" port (underneath the other hoses) to the "Y" adapter.



### INSTALLATION: 20-0295-12 Fuel Hanger Plumbing Kit, 2015+ Subaru STi, Dual Pump

Note the fuel line labels. Remove the 2 hoses attached to B and C. *Do not disconnect emission control line A.* Locate the 30" long hose with the 90 and 45 degree hose ends from the kit. Install the SAE female adapter fitting into the 45 degree end of this hose then slide it onto fuel line C. Use light oil for O-ring lubrication. Install the green retaining clip and small screw to secure the adapter to the fuel line. Route this hose under the sheet metal to the other side of the fuel tank and install on the "Y" fitting outlet, from the previous step.

Locate the 40" long hose with two 90 degree hose ends from the kit. Install the remaining SAE female adapter fitting into one of the 90 degree ends of this hose then slide it onto fuel line B. Secure with the green clip and small screw. Use light oil for O-ring lubrication. Route the hose to the other side of the fuel tank and connect it to the fuel hanger "RETURN" port. Tighten all fittings and hose ends.

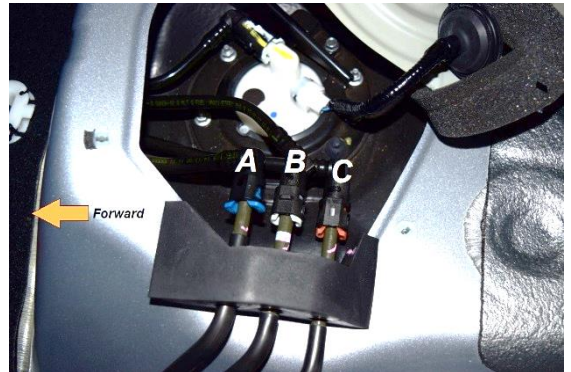

### INSTALLATION: 20-0295-12 Fuel Hanger Plumbing Kit, 2015+ Subaru STi, Dual Pump

Reinstall the OEM metal cover plates. Reconnect the battery and turn the key to the ON position. Confirm the new fuel pumps prime for a few seconds and check for leaks. If no leaks are found, start the vehicle. The engine may run rough for a few seconds until all the air is bled from the fuel system. Recheck for leaks. **Installation Complete**

**NOTES:** 1. This kit eliminates the OEM hanger's "post" fuel pump filter. A low micron aftermarket filter should be installed downstream to protect the injectors from debris. 2. Subaru models which have the FA20F engine do not have a return line. An external fuel pressure regulator (not included) will need to be installed into the fuel system.



### INSTALLATION: 20-0529-0X Fuel Plumbing Kit, 08-14 Subaru

Under the rear seat sheet metal, plastic fuel lines run between the active side and passive side of the fuel tank. Remove the passive side fuel tank access cover.

Identify the plastic fuel line that goes from the passive side of the fuel tank to the active side. This is the crossover fuel line. To completely remove this line, disconnect each end and unclip it from the bracket hidden in the cavity under the rear seat sheet metal (shown).

Remove the other two plastic lines. These are the feed and return lines that connect to the metal fuel lines traveling from the front of the vehicle and terminating near the active side of the gas tank.



### INSTALLATION: 20-0529-0X Fuel Plumbing Kit, 08-14 Subaru

The OEM crossover line will need to be replaced for both single or dual pump applications. First, locate the hose with a 90-degree hose end on one end and no hose end on the opposite end. First, install the 90-deg end to the port marked "CROSSOVER" on the fuel hanger. Run the new hose underneath the sheet metal to the passive (left) side of the gas tank.

Next, install the provided plastic SAE quick connect fitting's barb side into the PTFE hose and secure with the included EFI hose clamp (as shown). Lastly, use light oil for O-ring lubrication and install the SAE quick connect fitting on the passive side port where the OEM crossover hose was previously attached. When it is fully seated, a click will be felt. Gently tug the hose connection to verify a positive lock has been made. Adjust the positioning of the fittings as needed for optimal hose routing, then tighten all fittings.





**INSTALLATION: 20-0529-0X Fuel Plumbing Kit, 08-14 Subaru**

Find the fuel filter and adapter fittings provided in the kit.

Using light oil, lubricate the O-rings on the two 10AN ORB to 8AN male adapter fittings. Secure the fittings to the fuel filter ports using a non marring 1" wrench.



**INSTALLATION: 20-0529-0X Fuel Plumbing Kit, 08-14 Subaru**

Find the 2-piece fuel filter mount and sheet metal bracket in the kit.

Secure the lower filter mount to the bracket as shown using a 4mm Allen wrench and 8mm wrench.



**INSTALLATION: 20-0529-0X Fuel Plumbing Kit, 08-14 Subaru**

Center the fuel filter in the lower mount. Makes sure the green fuel filter outlet cap is pointing towards the small mounting hole on the bracket (or towards the engine when installed).

Using a 4mm Allen wrench, clamp the fuel filter using the upper mount and provided hardware.



**INSTALLATION: 20-0529-0X Fuel Plumbing Kit, 08-14 Subaru**

Safely lift the vehicle.

Find the area pictured located just inside of the front left wheel.

The fuel filter bracket will be mounted to the OEM threaded bosses shown.



**INSTALLATION: 20-0529-0X Fuel Plumbing Kit, 08-14 Subaru**

Peel the protective covering off both spots to expose the threads.



**INSTALLATION: 20-0529-0X Fuel Plumbing Kit, 08-14 Subaru**

Using 14mm and 10mm wrenches, secure the fuel filter bracket to the chassis, as shown.



**INSTALLATION: 20-0529-0X Fuel Plumbing Kit, 08-14 Subaru**

Just inside of the left rear tire will be a protective shield underneath the vehicle.

Unscrew all 5 protective shield bolts/nuts using a 12mm socket.



**INSTALLATION: 20-0529-0X Fuel Plumbing Kit, 08-14 Subaru**

Temporarily remove the protective shield from the vehicle.



**INSTALLATION: 20-0529-0X Fuel Plumbing Kit, 08-14 Subaru**

The fuel system will be plumbed as depicted.

NOTE: for single fuel pump applications, the "PUMP2" fuel line will not be used and the included -6AN cap will be installed to the corresponding "Y" adapter fitting.

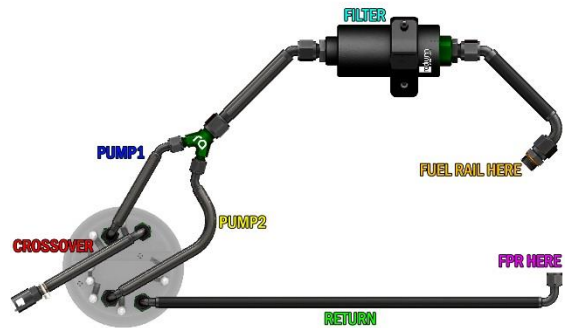

**INSTALLATION: 20-0529-0X Fuel Plumbing Kit, 08-14 Subaru**

The next step is to secure the 3 provided hose separators underneath the vehicle, as shown.

The front hose separator will be secured with the provided 14mm hex head sheet metal screw.

The rear 2 hose separators will be secured with the provided 10mm hex head M6x1mm bolts.



**INSTALLATION: 20-0529-0X Fuel Plumbing Kit, 08-14 Subaru**

When routing the hoses, start from underneath the vehicle. The -8AN PTFE fuel feed hose will be on the inner side and the -6AN (3/8") return hose on the outer side.

Place the fuel feed and return lines into their respective hose separator slots, as shown.



**INSTALLATION: 20-0529-0X Fuel Plumbing Kit, 08-14 Subaru**

Push the -6AN (3/8") return fuel hose up into the engine bay. Position the end of the hose where the fuel pressure regulator return port is located. NOTE: This hose will be cut to length and terminated in later steps.

Screw the -8AN feed line's 45 degree hose end to the fuel filter inlet fitting. Always, position hoses away from hot and/or tight areas that could chafe the hose. For LHD vehicles, pay close attention to the steering arm. Tighten using a 7/8" non marring wrench.



**INSTALLATION: 20-0529-0X Fuel Plumbing Kit, 08-14 Subaru**

The next couple steps will be securing the 2 fuel hoses one by one starting from the fuel filter and working back towards the rear of the vehicle.

First, fasten the hoses under the car near the transmission using the provided clamp and a 15mm socket, as shown.

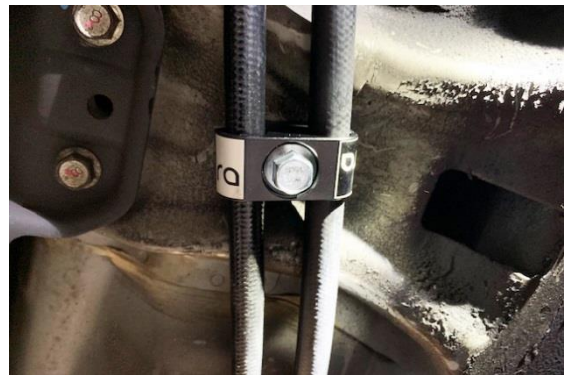

**INSTALLATION: 20-0529-0X Fuel Plumbing Kit, 08-14 Subaru**

Route the 2 fuel hoses up in front of the fuel tank so they can be accessed from the LH access panel inside the vehicle.

The hoses will pass the area of where the protective shield installs. To prevent chaffing, the protective shield will need to be slightly modified as shown.

Reinstall the protective shield and make any necessary corrections.



**INSTALLATION: 20-0529-0X Fuel Plumbing Kit, 08-14 Subaru**

Note the cut protective shield pictured.

Next, fasten the 2 fuel lines to the hose separators using the provided cable zip ties. Once tight, cut off the cable zip tie tails using diagonal cutters.



**INSTALLATION: 20-0529-0X Fuel Plumbing Kit, 08-14 Subaru**

Near the fuel filter, secure the fuel lines using the provided cable zip ties. For LHD vehicles, pay close attention to the steering arm.



**INSTALLATION: 20-0529-0X Fuel Plumbing Kit, 08-14 Subaru**

**FOR SINGLE FUEL PUMP APPLICATIONS ONLY**

Install the -8AN PTFE feed line and the provided -6AN cap and short -6AN PTFE line to the "Y" adapter. Run the -6AN PTFE line and return hose under the sheet metal and out the RH access panel. Secure the PTFE feed line to the "PUMP 1" port using an 11/16" non marring wrench.

Cut the return hose to length. To install the included -6AN 90deg hose end, first lubricate the PushLok hose end barbs with oil. Push the return hose over the barbs until fully seated. NOTE: hose clamps are NOT necessary for PushLok connections. Secure the return hose to the "RETURN" port using an 11/16" non marring wrench.



**INSTALLATION: 20-0529-0X Fuel Plumbing Kit, 08-14 Subaru**

**FOR DUAL FUEL PUMP APPLICATIONS ONLY**

Install the -8AN PTFE feed line and provided -6AN PTFE lines to the "Y" adapter fitting. Route the -6AN PTFE feed lines and return hose under the sheet metal and out of the RH access panel. Secure the PTFE feed lines to the "PUMP 1 & 2" ports using an 11/16" non marring wrench.

Cut the return hose to length. To install the included -6AN 90 degree hose end, first lubricate the PushLok hose end barbs with oil. Push the return hose over the barbs until fully seated. NOTE: hose clamps are NOT necessary for PushLok connections. Secure the return hose to the "RETURN" port using an 11/16" non marring wrench.



**INSTALLATION: 20-0529-0X Fuel Plumbing Kit, 08-14 Subaru**

If there is not an -8AN male fitting on the fuel rail, apply oil and install the provided -8AN fitting.

Next, install the included -8AN 45deg hose end to the provided -8AN (1/2") hose. First lubricate the PushLok barbs with oil, then push the hose on until fully seated. Install the hose end to the fuel filter outlet. Carefully route the feed hose towards the fuel rail and cut to length.

Finally, install the included -8AN and -6AN 90deg hose ends in the same manner to finalize the feed and return hoses. As shown, a vice can be helpful. NOTE: hose clamps are NOT necessary for PushLok connections. Secure the hose ends using 7/8" and 11/16" non marring wrenches.



**INSTALLATION: 20-0529-0X Fuel Plumbing Kit, 08-14 Subaru**

Reinstall the OEM metal cover plates. Reconnect the battery and turn the key to the ON position.

NOTE: There will be leftover parts from the kit that will not be used in every situation.

Confirm the new fuel pumps prime for a few seconds and check for leaks. If no leaks are found, start the vehicle. The engine may run rough for a few seconds until all the air is bled from the fuel system. Recheck for leaks.

**Installation Complete**

